

CP 483-16 – CP 483-34



2025 ©Väderstad Industries Inc. / 2025©Väderstad LLC

Väderstad®, Seed Hawk®, SCT®, iCon®, Tempo® , Till Drill®, Concord®, Soilpro® and Wil-Rich® are trademarks being used under license. Väderstad has made every attempt to accurately portray our product lineup. However, due to our commitment to continually innovate our technologies to provide our customers the best possible products, some products may not be manufactured as shown. Exact specifications for each product will be confirmed at the time of ordering.

30022480-en-us; 12.08.2024

<b>1</b>	<b>Introduction.....</b>	<b>1</b>	4.1	Troubleshooting the Chisel Pro.....	34
1.1	Description of the Machine.....	1	4.2	Notes.....	35
1.2	Intended Use.....	1	<b>5</b>	<b>Maintenance .....</b>	<b>36</b>
1.3	Illustrations of the Machine .....	2	5.1	Maintenance Schedules.....	36
1.4	Machine Serial Number .....	4	5.1.1	Daily .....	36
1.4.1	Serial Number Data Sheet .....	4	5.1.2	Every 50 Hours .....	37
1.5	Technical Data Sheet .....	5	5.1.3	1000 Hours / Yearly .....	37
1.6	Notes.....	6	5.2	Storage .....	38
<b>2</b>	<b>Safety.....</b>	<b>7</b>	5.2.1	Preparing the Machine for Storage .....	38
2.1	Safety Alert Symbols.....	7	5.3	Notes.....	39
2.1.1	Safety Information .....	7	<b>6</b>	<b>Specifications .....</b>	<b>40</b>
2.2	Safety Sign Information .....	7	6.1	Implement Specifications .....	40
2.3	Hand Signals .....	8	6.1.1	Wheels .....	40
2.4	Operator Responsibilities .....	9	6.2	Standard Bolt Torques .....	41
2.4.1	Key Safety Reminders .....	9	6.3	Hydraulic Connection Torques .....	42
2.5	General Safety .....	9	6.4	Notes.....	43
2.6	Maintenance Safety.....	10	<b>7</b>	<b>Aftermarket.....</b>	<b>44</b>
2.7	Hydraulic Safety.....	10	7.1	Warranty .....	44
2.8	Electrical Safety .....	11	7.1.1	What is Warranted .....	44
2.9	Transport & Towing Safety.....	11	7.1.2	Warranty Period .....	44
2.10	Storage Safety.....	11	7.1.3	Exceptions from this Warranty .....	44
2.11	Tire Safety.....	11	7.1.4	Owners Obligation.....	44
2.12	Hazards .....	12	7.1.5	Exclusive Effect of Warranty and Limitation of Liability .....	44
2.13	Safety Signs.....	13	7.1.6	Additional Warranty Information .....	45
2.13.1	Location of Safety Signs .....	13	7.2	Optional Attachments.....	45
2.13.2	Safety Lighting .....	20	7.2.1	Leveling Attachments.....	45
2.14	Notes.....	21	7.3	Notes.....	46
<b>3</b>	<b>Operation.....</b>	<b>22</b>	<b>Appendix.....</b>	<b>47</b>	
3.1	Hydraulic Connections .....	22	<b>Index.....</b>	<b>49</b>	
3.2	Preparation.....	22			
3.2.1	Tractor Preparation .....	22			
3.2.2	Torque Check.....	22			
3.2.3	Hydraulics.....	22			
3.2.4	Wheel Preparation .....	22			
3.2.5	Lubrication.....	23			
3.3	Connecting the Implement.....	24			
3.4	Transporting .....	25			
3.5	Field Operation Preparation .....	26			
3.6	Field Operation Leveling Adjustments .....	27			
3.7	Field Operation Settings.....	28			
3.8	Notes.....	33			
<b>4</b>	<b>Troubleshooting.....</b>	<b>34</b>			



# 1 Introduction

## 483 Chisel Pro

Congratulations on the choice of a **483 Chisel Pro** to complement the farming operation. These units have been engineered to loosen soil, bury heavy trash, and properly size clods for a smoother field finish. The 483 Chisel Pro is the ideal tool for today's high yielding crops.

All persons authorized to operate this implement are responsible for reading and understanding the contents of this Operator's Manual, especially the Safety Section. The owner or operator (user) should seek assistance from the dealer, distributor or manufacturer for any information not fully understood regarding the safe operation adjustment, maintenance, or repair of this implement.

The user is responsible for inspecting the machine and for having components repaired or replaced when continued use of this product would cause damage or excessive wear to other components.

Keep this Operator's Manual in a clean, dry place that is easily accessible for reference when more detailed information is required to perform tasks related to the operation, adjustment, maintenance, or repair of this implement. It is further recommended that the contents of this Operator's Manual be reviewed at least annually by persons operating, adjusting, maintaining, or repairing this implement, and any time a new person is assigned to any of the above mentioned tasks.

Any information in this Operator's Manual that is not fully understood should be clarified by contacting the dealer, distributor, or manufacturer and requesting assistance.

The contents of this Operator's Manual are accurate up to the time of printing.

It is the policy of Väderstad Inc. to improve its products whenever possible and practical to do so. Väderstad Inc. reserves the right to make changes, improvements and modifications at any time without incurring obligation to make such changes, improvements on any equipment sold previously.

*Address inquiries to:*

- Väderstad Inc. PO Box 1030, Wahpeton, ND 58074
- PH (701) 642-2621

## 1.1 Description of the Machine

Built with 24 in (61 cm) concave razor blades and 1,400 lb (635 kg) trip pressure shanks, the 483 Chisel Pro gives the soil mixing of a ripper and the width of a chisel plow. Because it works at a maximum depth of 10 in (25 cm), the 483 Chisel Pro requires less horsepower than a disk ripper, allowing for wider working widths and more productivity.

Four ranks of 1,400 lb (635 kg) trips with on-edge chisel shanks give additional digging and mixing after the disks. 60 in (152 cm) spacing between shanks on each of the ranks allows for excellent trash flow through the tool. The overall 15 in (38 cm) spacing aids in a smoother field finish than the typical wider shank spacing of disk rippers.

Two rows of double-mounted disks can be set for desired depth independent of the shanks. Concave razor blades are 24 in (61 cm) in diameter and spaced 15 in (38 cm) apart. The second rank of blades is offset from the first for effective spacing of 7-1/2 in (19 cm).

The floating hitch on the 483 Chisel Pro provides exceptional depth control and ground following capability.

22-1/2 in (56 cm) walking tandems provide better flotation and easier transport.

## 1.2 Intended Use

Wil-Rich Disk Chisels are intended to be used as a primary tillage option that provides consistent tillage across the width of the machine. Offering an effective and reliable option for seedbed preparation.



All references to "LEFT" and "RIGHT", as used throughout this manual, are determined by facing the direction of the machine's normal forward travel when in use.



Some images in this Operator's Manual may show the machine with shields removed to better show the subject of the picture. The implement must NEVER be operated with any of the shields either opened or removed. Ensure that ALL shields are attached, closed and in good working condition prior to operating the Wil-Rich implement.

1.3 Illustrations of the Machine

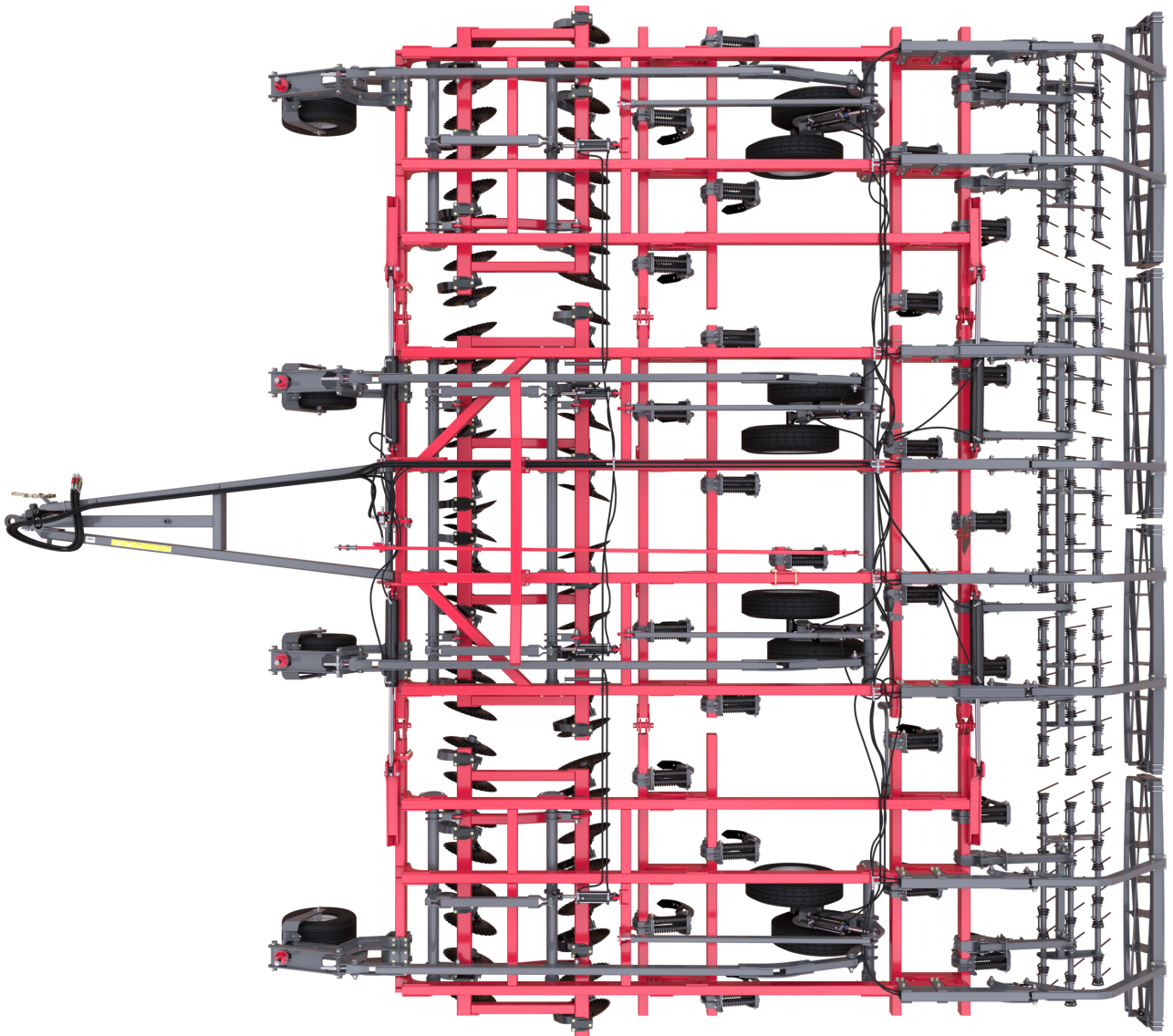

Figure 1.1 483-34F Chisel Pro (Top)

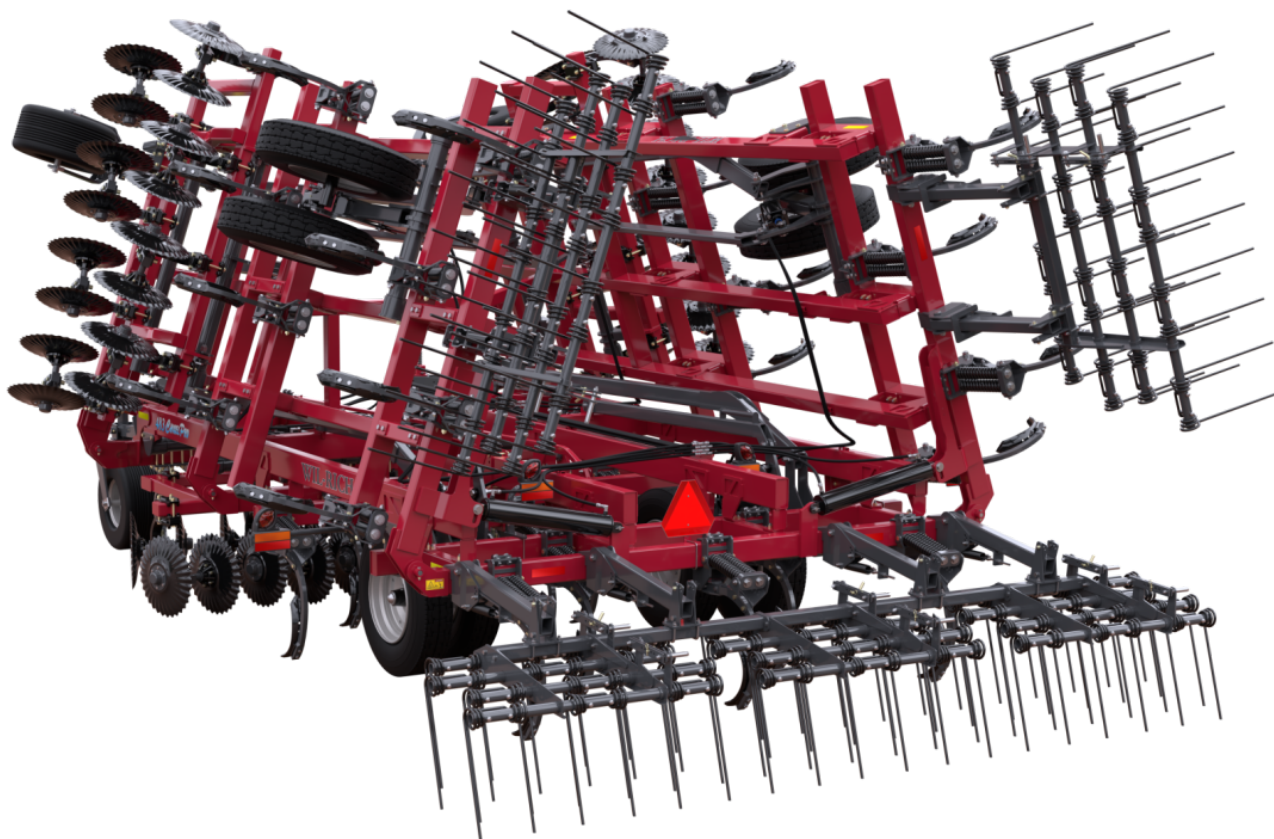

Figure 1.2 483-34F Chisel Pro (Folded)



Figure 1.3 483-34F Chisel Pro (Side)

# Introduction

---

## 1.4 Machine Serial Number

[Refer to Section “2.13.1 Location of Safety Signs on page 13” for more information on the location of the safety decals and the serial number plate.](#)

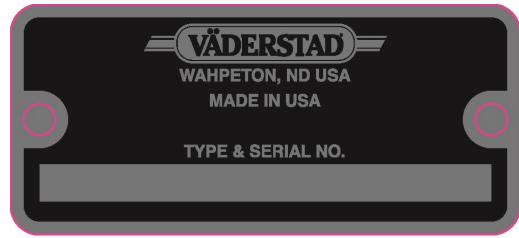

Figure 1.4 Serial No. Decal

### 1.4.1 Serial Number Data Sheet

Record the machine model and serial number in the spaces provided below. Use these numbers when contacting the dealer for repair parts, warranty or service assistance.

#### Serial Number(s)

Implement(s) Serial Range: XX00000000 - XX00000000		
Implement	Model	Serial Number(s)
Chisel Pro		
Other		



## 1.5 Technical Data Sheet

Table 1.1 Technical Data Sheet: 2025 483 Chisel Pro

<b>Models</b>	<b>483-16</b>	<b>483-19</b>	<b>483-24</b>	<b>483-29</b>	<b>483-34</b>
<b>Dimensions</b>					
Working Width, ft (m)	16.25 (5)	18.75 (5,7)	25 (7.6)	28.75 (8.8)	33.75 (10.3)
Shank Spacing, in (cm)	15 (38)	15 (38)	15 (38)	15 (38)	15 (38)
Transport Width, ft (m)	17.5 (2.3)	20 (6)	20 (6)	20 (6)	20 (6)
Transport Height, ft (m)	6 (1.8)	6 (1.8)	12 (3.7)	13 (4)	15 (4.6)
Transport Length, ft (m)	35.3 (10.8)	35.3 (10.8)	35.3 (10.8)	35.3 (10.8)	35.3 (10.8)
Weight, lbs (kg)	15,469 (7,017)	16,981 (7,702)	27,157 (12,318)	29,879 (13,553)	33,103 (15,015)
<b>Specifications</b>					
Number of Shanks	13	15	19	23	27
Number of Blades	24	32	40	48	56
Horsepower Requirement	240 — 360	300 — 450	380 — 570	460 — 620+	540 — 620+



## 2 Safety

### 2.1 Safety Alert Symbols

#### 2.1.1 Safety Information

The Safety Alert Symbol(s) are intended to direct the attention of the machine user to important safety information both published in the Operator's Manual and applied to the machine. Any time Safety Alert Symbol(s) are seen, it means that associated information is provided for recognizing, appropriately responding to and avoiding potentially hazardous situation(s).

A triangle shape surrounding an exclamation point indicates a potentially hazardous situation. Information included in a safety sign or printed in the Operator's Manual describes the hazardous situation and indicates appropriate response(s) and / or avoidance procedures.

**This Safety Alert Symbol means:**



### Attention Be Alert!



**DANGER!** Indicates an imminently hazardous situation that, if not avoided, **WILL** result in death or serious injury if the proper precautions are not taken.



**WARNING!** Indicates a potentially hazardous situation that, if not avoided, **COULD** result in death or serious injury if the proper precautions are not taken.



**CAUTION!** Indicates a potentially hazardous situation that, if not avoided, **MAY** result in minor or moderate injury if the proper practices are not taken, or, serves as a reminder to follow appropriate safety practices.



**NOTE!** Used to clarify information.



**IMPORTANT!** The information next to this symbol may be worth noting since it is a hint containing particularly useful information on how to handle the machine. Failure to follow these notices may result in damage to the machine.

### 2.2 Safety Sign Information

**Safety Sign Legibility:** All safety signs applied to the implement must be visible and legible. Keep dust and dirt cleared from safety signs and ensure that visibility is not obscured.

**Safety Sign Replacement:** Safety signs may be ordered through the dealer or distributor. Contact Väderstad Inc. if unable to obtain replacement safety signs from a dealer or distributor.

**Damaged or Deteriorated Safety Signs:** Remove and replace any safety signs that have either been damaged or show signs of deterioration.

**Safety Signs on Replacement Parts:** Ensure that parts or components that are replaced on the implement that had a safety sign attached originally include a safety sign.



For parts and decal replacement, contact your local dealer parts department.







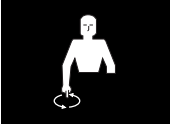

#### *Affixing Safety Signs to the Implement*

1. Ensure proper position and orientation before installing.
2. Ensure installation area is clean and dry.
3. Ensure ambient temperature is above 50°F (10°C).
4. Remove backing material to expose label adhesive.
5. Place one edge of label to machine surface.
6. Slowly press the label onto the surface.
7. Ensure no air pockets are present or become trapped under surface or label. To remove air pocket, pierce the bubble in the label with a pin, this will let the trapped air out, and then press the label down.

### 2.3 Hand Signals

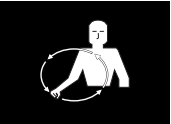
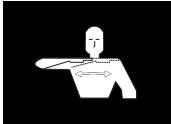
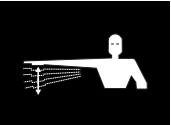
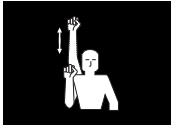
Hand signals are an important means of communication on farms where noise levels and distance can hinder regular communication between workers. These 11 hand signals were created so that two or more persons can communicate effectively and safely.

Table 2.1 Hand Signals

	Lower Equipment: Make a circular motion with either hand pointing to the ground.		Raise Equipment: Make a circular motion with either hand at head level.
	Come to me: Raise the arm vertically overhead, the palm to the front, and rotate in large horizontal circles.		This far to go: Place palms at ear level facing the head and move laterally inward to indicate remaining distance to go.
	START THE ENGINE: Simulate cranking of vehicles by moving arm in a circular motion at waist level.		STOP THE ENGINE: Draw right hand, palm down, across the neck in a “throat cutting” motion from left to right.
	Slow it down / decrease speed: Extend the arm horizontally to the side, palm down, and wave arm downward 45 degree minimum, repeat.		Speed it up / increase speed: Raise the hand to the shoulder, fist closed, thrust the fist upward to the full extent of the arm and back to the shoulder rapidly, repeat several times.
	Move-Out: Face the desired direction of movement, hold the arm extended to the rear; swing it overhead, forward in the direction of the desired movement until it is horizontal, palm down.		Move toward me / follow me: Point toward person(s), vehicle(s), or unit(s) beckon by holding the arm horizontally to the front, palm up, and motioning toward the body.
	Stop: Raise hand upward to the full extent of the arm, palm to the front. Hold that position until the signal is understood.		To perform any / or all of these signals, stand out of the pathway of the moving implement.

## 2.4 Operator Responsibilities

Responsibility for the safe operation, adjustment, maintenance and repair of this machine falls to the main user. It is the responsibility of the owner, or authorized person in charge, to ensure all persons who operate, adjust, maintain and/or repair this implement be familiar with the information provided in this Operator's Manual before performing any other tasks listed above.

A safe user is the key to safety. Good safety practices not only protect the user, but also persons who may be in the vicinity of the implement. Make good safety practices a part of the farming operation. Ensure that all persons operating, adjusting, maintaining and/or repairing this implement are familiar with the procedures recommended in this manual.

Always read safety warnings and follow recommended safety precautions to avoid hazardous situations. DO NOT risk personal injury or death by ignoring safety warning and safety precautions.

### 2.4.1 Key Safety Reminders

The most important safety device is a safe and qualified user.

A safe and qualified user is one who has read and understands the contents of the Operator's Manual prior to performing any tasks related to the machine. Owners have a responsibility to provide training to persons who may operate, adjust, maintain and/ or repair the implement prior to performing any of these tasks.

DO NOT perform any unauthorized modifications to the implement or use the implement for any purpose other than what is described in the contents of this Operator's Manual.

Owners must give operating instructions to operators and employees before allowing them to operate the implement, and at least annually thereafter per OSHA regulation 1928.57.

## 2.5 General Safety

Read and understand the contents of this Operator's Manual prior to operating, adjusting, maintaining and/or repairing the implement. Review at least annually thereafter.

Locate, read and understand all safety signs applied to the implement before performing any tasks.

Review the contents of this Operator's Manual at least annually, and, any time a new person is assigned to perform any tasks with the implement.

Ensure that all bystanders, especially small children, and pets/animals are kept at a safe distance while performing any tasks with the implement. Keep all personnel away from moving parts.

Do not stand between the tractor and implement to install the hitch pin while the tractor engine is running.



DO NOT allow riders on any part of the implement.

When parking, park the machine and the tractor on a solid level surface. Put all controls in neutral and apply the tractor park brake. Stop the tractor engine and take the key with you.

Always lower the machine when not in use and relieve the pressure in the hoses and cylinders.

Ensure all guards and shields are intact and in place prior to operating the implement.

Keep hands, feet, hair and loose clothing away from moving and/or rotating parts.

Stop the engine, lower the implement, set the parking brake, remove the ignition key, and allow time for moving parts to stop prior to adjusting, maintaining, and/or repairing the implement.

Ensure that all implement lighting and marking is intact, secure, clean and operating properly prior to traveling on public roads. Check with local highway authorities to confirm implement is properly equipped for highway travel.

Provide a fully stocked First-Aid Kit in a highly visible and easily accessible location.

Ensure a fire extinguisher is available for use should the need arise and that the operator is familiar with its proper use.

Clear the implement of any and all foreign objects before beginning operation.

Ensure that the implement is securely blocked and supported prior to working underneath.

Do not work with the machine during thunderstorms and when there is a risk of lightning strikes. Do not stand on or next to the machine.

Always wear suitable ear protection for prolonged exposure to excessive noise.

Use caution when working around high pressure hydraulic systems.

Reduce speed when cornering on field ends and when operating on or across dead furrows.

Do not attempt to remove any obstruction while the machine is in motion.

Use extreme caution when operating close to ditches, fences or on hillsides.

No one other than the operator should ride on the tractor.

In the event of a fire in a crop / field setting, use a water type fire extinguisher or other water source. For fires involving anything other than crop, such as oil or electrical components. Use a dry chemical fire extinguisher with an ABC rating.

### 2.6 Maintenance Safety

Read and understand all information provided in the Operator's Manual covering operation, adjustment, maintenance and repair prior to performing any of these tasks. Plan work to ensure proper tools, equipment, and personal protective equipment is available prior to working on implement.

Wear appropriate clothing when performing tasks around implement. Ill-fitting and/or frayed clothing as well as loose or dangling items should not be worn when working near the implement.

Stop the engine, lower the implement, set the parking brake, remove the ignition key, and allow time for moving parts to stop prior to adjusting, maintaining, and/or repairing the implement.

Ensure that all moving parts have come to a complete stop before performing adjustments, maintenance and/or repairs.

Ensure that hydraulic oil pressure in hoses, lines, and components is fully relieved prior to performing any maintenance, and/or repairs.

Ensure that wings are either fully lowered or fully raised and secured using transport/cylinder locks (if equipped) or securely block the wings if raised to perform adjustments, maintenance and/or repairs as needed.

Securely block main frame and/or wings (any raised components) if adjustments, maintenance, and/or repairs are required.

Wear personal protective equipment, such as gloves, eye protection, etc. when inspecting the hydraulic system for leaks. Use a small piece of cardboard or wood to detect leaks.

Ensure that all guards and shields are intact and in place after performing adjustments, maintenance and/or repairs prior to operating implement.

Store flammable fluids in approved containers and store out of access by unauthorized persons, especially children.

Replace the safety chain if one or more links or end fittings are broken, stretched or otherwise damaged or deformed.

Do not allow children or other unauthorized persons within the implement operational area.

Do not modify the equipment or substitute parts in any way. Unauthorized modification may impair the function and / or safety of the machine.

Use a suitable lifting device for components which could cause personal injury by pinching, crushing or weight. Be sure lifting device is rated to handle the weight.

Always inspect lifting chains and slings for damage or wear.

Ensure all hydraulic connectors are cleaned of any dirt or debris regularly to ensure proper connection to tractor.

### 2.7 Hydraulic Safety

Always place all tractor hydraulic controls in neutral before dismounting.

Ensure that all hydraulic system components are kept clean and in proper working condition.

Relieve pressure before working on hydraulic system.

Use a piece of cardboard or wood to check for hydraulic leaks.

Wear personal protective equipment, such as gloves, eye protection, etc. if unsure if residual pressure may exist in hydraulic components during troubleshooting and/or making repairs.

If injured by a concentrated high-pressure stream of hydraulic fluid, seek medical attention immediately. Serious infection or toxic reaction can develop from hydraulic fluid piercing the skin surface.

Check hydraulic hoses regularly for wear and tighten/replace as needed. Contact your local Dealer parts department to purchase replacement hoses specifically designed for Wil-Rich machines.

When connecting the hoses to the cylinders, tubings or fittings; always use one wrench to prevent the hose from twisting and another wrench to tighten the union. Excessive twisting will shorten hose life and loosen hose fittings.

DO NOT attempt any makeshift repairs to the hydraulic lines, fittings or hoses by using tape, clamps or cements. The hydraulic system operates under extremely high-pressure. Such repairs will fail suddenly and create a hazardous and unsafe condition.

Do not over-tighten hydraulic fittings, excessive torque may cause them to crack.

Always contact the nearest Wil-Rich dealer or service professional when replacing hydraulic hoses.

When replacing hoses always route hoses the same as the one being replaced to ensure that the part is not subjected to wear, rubbing, kinking, etc. Make repairs following instructions provided by the manufacturer.

Ensure all fittings, couplings, and other hydraulic connections are intact and properly tightened before operating implement hydraulic system.



**DO NOT touch pressurized hose assemblies with any part of the body. If fluid punctures the skin, seek immediate medical attention.**

---

Hydraulic fluids are highly flammable. Always keep open flames and ignition sources away from hydraulic fluids.

## 2.8 Electrical Safety

Ensure that the machinery is shut off and all electrical components are disconnected before doing any work on the machine. Ensure all live connections are not receiving power.

Check electrical wires regularly for wear related to usage and weathering. Replace any damaged wires or components immediately.

Use insulated tools whenever performing service to any electrical system or components and always wear proper protective equipment.

## 2.9 Transport & Towing Safety

Read and understand ALL the information in the Operator's Manual regarding procedures and SAFETY when moving the implement in the field / yard or on the road.



DO NOT allow riders on any part of the implement.

Ensure that implements are attached to the tractor properly.

Ensure transport cylinder locks are in place and functioning properly (if equipped).

Ensure safety tow chain is securely attached and retaining clip is securely locked in place.

Ensure all lighting and implement marking devices are intact and visible.

Ensure implement is properly marked according to local road regulations.

**Read and follow all local road traffic regulations.**



DO NOT exceed recommended transport speeds (*Maximum: 20 mile/hr / 32 km/hr for wheel-driven machines, 15 mile/hr / 24 km/hr for track-driven machines*). The implements are not designed for high speed use. Ensure all local traffic rules/regulations are followed. Reduce speed and use caution when making corners and meeting traffic.

Make sure you understand the speed, steering, stability and load characteristics of this machine before you travel on public roads. Use good judgement when traveling on public roads. Maintain complete control of the machine at all times. Never coast down hills.

Be aware that the implement is wider than the tractor when transporting. Always have the wings completely folded (if equipped) when transporting on public roads.

Watch for overhead wires and other obstructions. Avoid contact with electrical power lines. Contact with electrical power lines can cause electrical shock, resulting in very serious injury or death.

Make sure SMV (Slow Moving Vehicle) emblem and all lights and reflectors that are required by the local highway and transport authorities are in place, are clean and can be seen clearly by all overtaking and oncoming traffic.

Keep to the right and yield the right-of-way to allow faster traffic to pass. Drive on the road shoulder, if permitted by law.

Always use hazard warning flashers on tractor when transporting unless prohibited by law.

Frequently check for traffic, especially during turns.



Always bring the machine to a complete stop before folding/unfolding. Switching between transport and working positions while in motion may result in damage to the implement.



When in working position, ensure wing fold cylinders are fully extended prior to field operation.

## 2.10 Storage Safety

Store the implement away from areas of human activity.



DO NOT allow children to play on or around the implement(s).

Store the implement on a dry, stable, and level surface away from areas of human activity. Support with planks if required.

## 2.11 Tire Safety

Ensure tire inflation pressure is maintained per specifications.

Do not attempt to mount a tire unless you have the proper equipment and experience to do the job.

Follow proper procedures for tire repairs, especially when mounting tire to the rim.

Seek assistance from a trained person for tire repairs or mounting, especially if specialized equipment is required.

### 2.12 Hazards

The key is to recognize hazards while working or living on a farm; avoid dangerous situations or at least minimize the exposure to them.

This section deals with danger points on agricultural equipment; those areas which can entangle, pinch, crush, or shear clothing and limbs. Possible danger points could be wing fold points, hydraulic cylinders and hydraulic lines on many types of equipment.

A slow-moving hydraulic arm can be as hazardous as a rapidly rotating power take-off shaft.

#### Recognize the dangers!

The first step to avoiding danger is to recognize that hazards exist. Identify the specific hazards associated with the equipment.

The next step is to consider how to use the equipment. Using it for tasks it was meant to perform? Following all safety precautions recommended by the manufacturer?

Most machinery accidents result from human error. The operator either forgot something, took a shortcut, ignored a warning, wasn't paying close attention, or failed to follow safety rules. Be familiar with the operator manual, know the limitations of the equipment, and follow safety measures automatically.

Carefully evaluate the operation of each implement for safety before starting work.

#### Check equipment guards.

Check guards on all equipment as part of a routine maintenance schedule. During seasons when equipment is used heavily, check guards more often.

Equipment guards cannot eliminate all injuries.

A transport lock will only work if it is engaged prior to road transport, and will not prevent accidents if it is not engaged.

#### Recognize secondary hazards.

Many farm injury victims recognize hazardous situations, but they misjudge the seriousness of the hazard because of secondary factors.

For example, spilled grain or debris in an unloading area could cause someone to slip and fall into the intake auger. Icy, muddy, or manure-covered surfaces make the work area slick and increase the risk of injury. Bystanders or children in the work area can distract the operator, or limit operator vision.

Never stand near the machine during operation. Debris can be thrown from the machine during operation possibly resulting in injury.



Be careful when operating along the side of a road or building. Rocks or other debris can be thrown from the machine during operation possibly resulting in injury.

---

High pressure hydraulic oil is a major hazard. Any leaks in the hydraulic system must be treated as a dangerous situation and should be dealt with accordingly.

#### Consider human factors.

Farm operators can overestimate their ability to stop or avoid a dangerous situation. This is common when operators work around powerful equipment every day and become comfortable with their ability to control the machinery.

Operators are also limited by their reaction time. Human reaction time is not quick enough to avoid an injury with machinery.

Gravity as well is faster than human reaction. For example, it is very dangerous to reach underneath the wing of a machine if the transport/safety locks are not correctly in place. If a hydraulic line breaks, gravity could pull the machine wings to the ground very quickly, crushing the operator.

Manufacturers have built safeguards into equipment but all hazards cannot be removed. Take a realistic approach to equipment safety and think about these principles for the operation of all machinery.

- Be aware of the dangers. Read the operator manuals and think about how to use the equipment.
- Regularly repair and replace protective guards or shields on all implements.
- Look for and remove secondary hazards, such as spilled grain or debris.
- Recognize the limitations of the user and the equipment.

#### *Farm Machinery Safety: What to do?*

- A few simple actions can reduce the risk of danger around farm machinery.
- Collect operator manuals for all farm equipment and place in a central location. Read the safety section in each manual.
- Evaluate how to anticipate using each implement and identify potential safety hazards not mentioned in the manual.
- Check condition of intake guards and shields on grain augers and other implements.
- Remove debris from grain unloading areas. Shut down equipment when other people enter the area.



## 2.13 Safety Signs

### 2.13.1 Location of Safety Signs

The types of safety decals and locations on the equipment are shown below. Safety requires that you familiarize yourself with the various safety decals, the type of warning and the area or particular function related to that area, that requires your safety awareness.



If Safety Decals have been damaged, removed, become illegible or parts replaced without safety signs, new signs must be applied. New safety signs are available from your authorized dealer.

#### 1. **WARNING** Crushing Hazard

- Cylinder locks must be used. P/N: 997864-01



Figure 2.1 (1) Crushing Hazard

- Right and left sides main frame.



Figure 2.2 (1) Location I

- Right and left side transport wheel cylinder locks.



Figure 2.3 (1) Location II

## Safety

### 2. DANGER Stand Clear

- Do not stand under raised wing sections. P/N: 997854



Figure 2.4 (2) Stand Clear

- Main frame left and right wing hinge.



Figure 2.5 (2) Location

### 3. WARNING Prevent Serious Injury from Moving Parts



Figure 2.6 (3) Prevent Serious Injury from Moving Parts

### 4. WARNING Bleed Air From All Series Cylinders



Figure 2.7 (4) Bleed Air From All Series Cylinders

- All rolling basket lift cylinders.



Figure 2.8 (3) Location I

- Left and right wheel lift cylinders.



Figure 2.9 (3) Location II / (4) Location

5. **CAUTION** Read Manual Before Connecting

- P/N: 997856



Figure 2.10 (5) Read Manual Before Connecting

6. **WARNING** Read Manual Before Disconnecting

- P/N: 997852



Figure 2.11 (6) Read Manual Before Disconnecting

- Left front main frame.

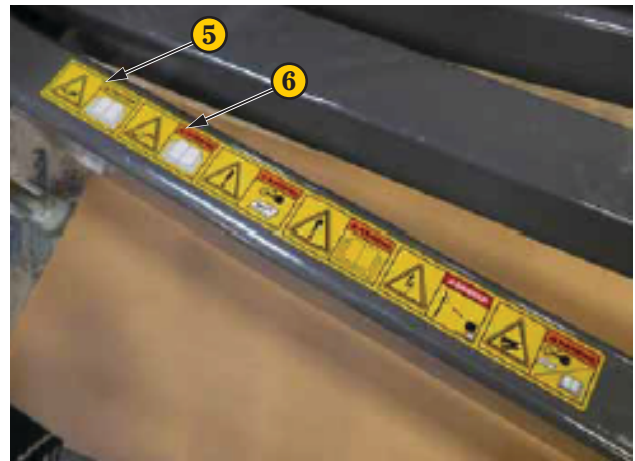

Figure 2.12 (5) Location / (6) Location

## Safety

### 7. WARNING Shut Engine Off

- Read manual before maintenance. P/N: 997858



Figure 2.13 (7) Shut Engine Off

### 8. WARNING Read Manual

- P/N: 997860



Figure 2.14 (8) Read Manual

- Left front main frame.



Figure 2.15 (7) Location / (8) Location I

- Left front main frame.

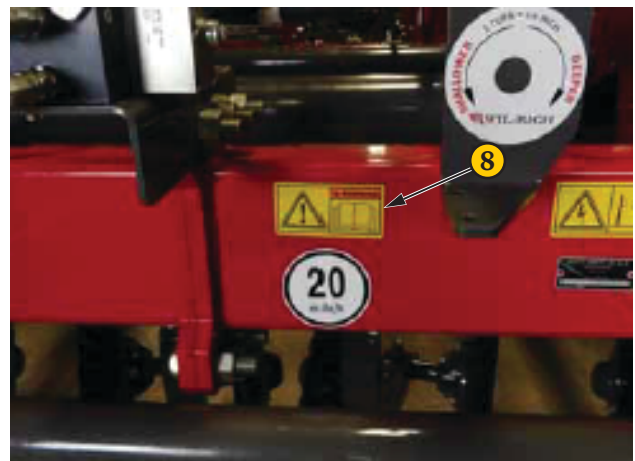

Figure 2.16 (8) Location II

9. **DANGER** Electrocutation Hazard

- P/N: 997862



Figure 2.17 (9) Electrocutation Hazard

10. **WARNING** Hydraulic Hazard

- P/N: 997866



Figure 2.18 (10) Hydraulic Hazard

- Left front main frame.

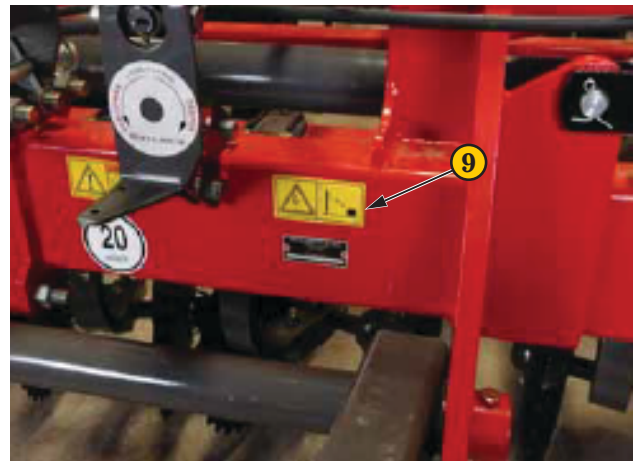

Figure 2.19 (9) Location I

- Left front main frame.



Figure 2.20 (9) Location II / (10) Location

# Safety

## 11. Maximum Safe Travel Speed

- P/N: 9971018



Figure 2.21 (11) Maximum Safe Travel Speed

- Left front main frame.

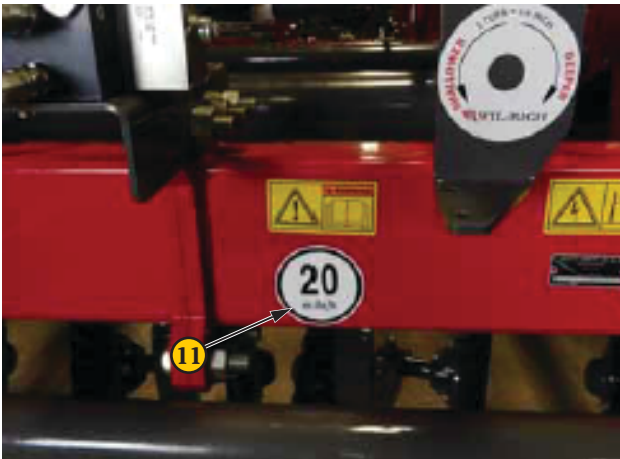

Figure 2.22 (11) Location

## 12. Amber Reflector Decal

- P/N: 22372



Figure 2.23 (12) Amber Reflector

- Front side of all safety lights.



Figure 2.24 (12) Location I

- Front and side of both wings.



Figure 2.25 (12) Location II

13. Red—Orange Reflector Decal

- P/N: 223118



Figure 2.26 (13) Red-Orange Reflector

- Rear side of all safety lights.



Figure 2.27 (13) Location

14. Red Reflector Decal

- P/N: 22371



Figure 2.28 (14) Red Reflector

- Rear outside corner of both LH and RH wings and main frame.



Figure 2.29 (14) Location

15. SMV Slow Moving Vehicle

- P/N: 41345



Figure 2.30 (15) Slow Moving Vehicle

- Center of wing stop bracket.

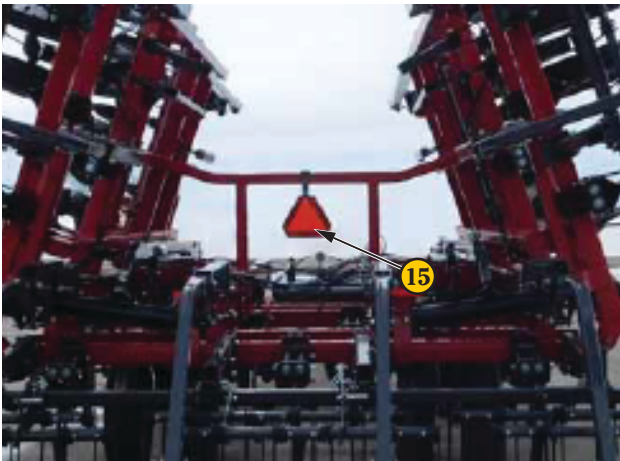

Figure 2.31 (15) Location

16. Serial Number Plate

- P/N: 338957

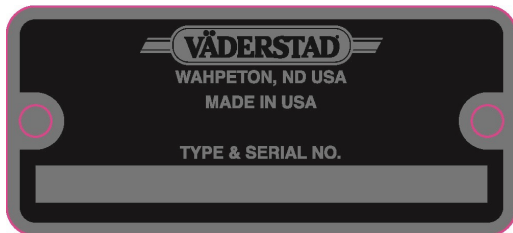

Figure 2.32 (16) Serial Number Plate

- Main frame on the front left above the hitch frame.

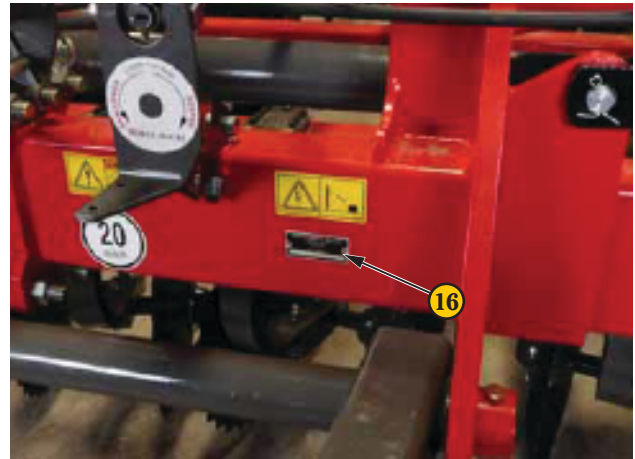

Figure 2.33 (16) Location

2.13.2 Safety Lighting

The Safety Light Kit is equipped with a 7-pin connector. To protect the 7-pin connector, store in dust cap (1) located on the front of the hitch when not attached to towing vehicle.



Figure 2.34 Safety Lighting





### 3 Operation

#### 3.1 Hydraulic Connections

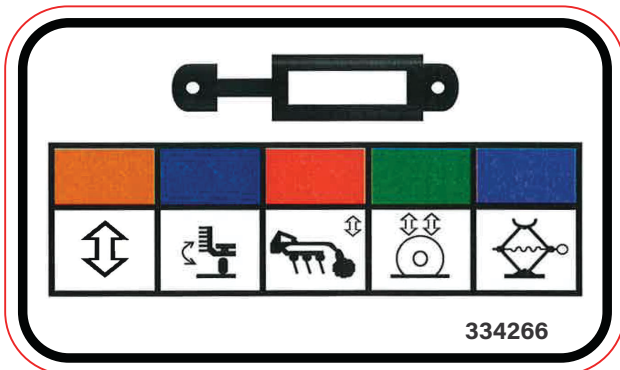

Figure 3.1 Hydraulic Connection Decal

#### 3.2 Preparation

##### 3.2.1 Tractor Preparation

[Refer to the operator's manual furnished with your tractor for recommended adjustments and weight distribution.](#)

##### 3.2.2 Torque Check

Before using the implement a careful inspection must become routine.

Check to be sure that all hardware is securely tightened and moving parts properly lubricated.

[Refer to Section "6.2 Standard Bolt Torques on page 41" for torque specifications.](#)

##### 3.2.3 Hydraulics

1. On all new machines check the hydraulic system to be sure all fittings are tight.
  - [Refer to Section "6.3 Hydraulic Connection Torques" for hydraulic fitting torque specifications.](#)



Figure 3.2 Hydraulic Preparation

##### 3.2.4 Wheel Preparation

The use of the proper air pressure is the most important factor in satisfactory performance and maintenance of implement tires. Under-inflation will damage the cord body of the tire and cause a series of diagonal breaks in the fabric of the sidewall area.

If the tire buckles or wrinkles, the air pressure must be increased to the point where the sidewalls remain smooth while operating.



Figure 3.3 Wheel Preparation



Do not over-inflate tires! [Refer to Section "6.1.1 Wheels on page 40" for tire pressure and torque specifications.](#)

Check the air pressure every two or three weeks and do not allow pressure to drop to a point where buckling or wrinkling of the tire may be possible.

It is recommended that all wheel nuts be checked for tightness after first day of use. Check periodically to be sure the wheel nuts are tight. Paint or rust can work out causing the wheel to become loose.

**3.2.5 Lubrication**

1. Grease the eight bearings (A) on the rear flat bar roller.

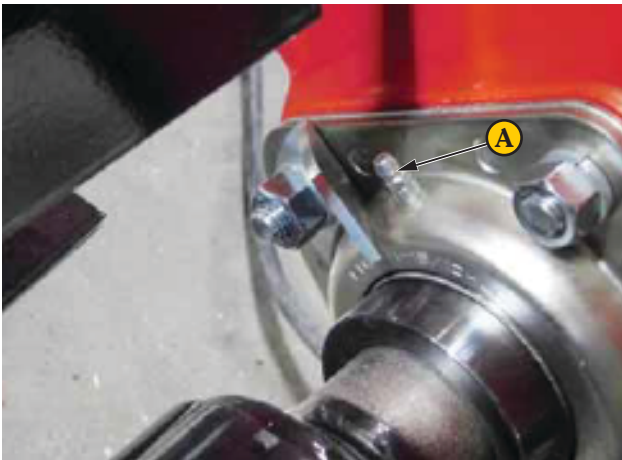

*Figure 3.4 Lubrication I*

2. Grease the four front lift wheel pivot spindles (B).

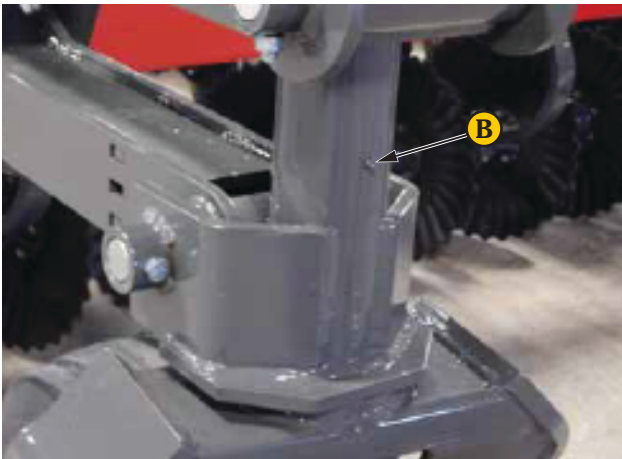

*Figure 3.5 Lubrication II*

3. Grease all the lift wheel hubs (C).



*Figure 3.6 Lubrication III*

4. Grease each disk hub (D).



*Figure 3.7 Lubrication IV*

## Operation

### 3.3 Connecting the Implement



Never allow anyone between the tractor and implement when connecting or disconnecting until the implement is completely supported on the 3-point hitch, the engine is stopped and the park brake is applied.

1. Use the jack (A) to align the implement tongue (B) with the tractor drawbar (C). Slowly back the tractor onto the tongue (B) and install the pin (D).
2. Retract the jack until the implement tongue and hitch are supported by the tractor. Remove the pin (E) and remove the jack.

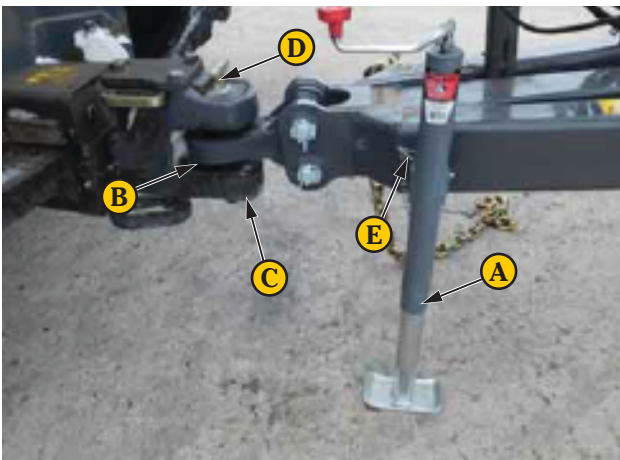

Figure 3.8 Connecting the Implement I



Be sure the pin mechanical lock device is in place. The device may be a pin lock plate as shown or a cross pin on the drop pin.

3. Install the jack (F) in the storage position on the drawbar as shown. Secure with the pin (G).

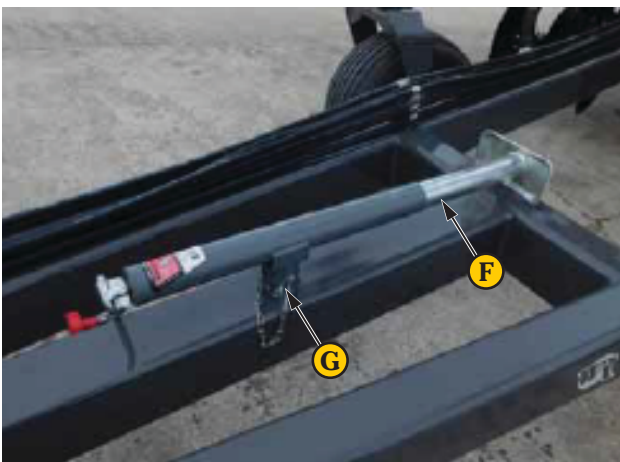

Figure 3.9 Connecting the Implement II

4. Install the safety chain (H) as shown.



Be sure the safety chain lock (I) is secured.

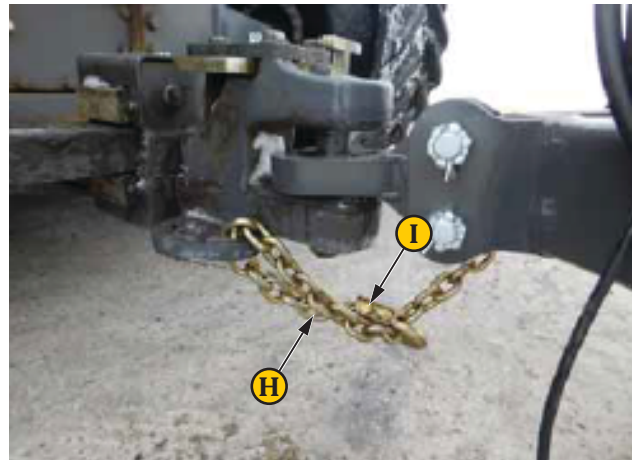

Figure 3.10 Connecting the Implement III

5. Install the wing lift, shank lift, wheel lift and rolling basket cylinder hoses on the tractor. Be sure the hose couplers are secured in the tractor couplers.



Figure 3.11 Connecting the Implement IV

6. Install the safety light connector (J) on the tractor.



Figure 3.12 Connecting the Implement V

### 3.4 Transporting

1. A Slow Moving Vehicle (S.M.V.) emblem must be used at all times while traveling on public roads.

Be sure all safety lights are working. Obey all local, state and federal laws for lighting requirements.



Figure 3.13 Transporting I

2. Always fold the wings up before transporting.



If the implement has been stored or out of operation for months or if hydraulic wing cylinders have recently been replaced perform the following procedure.

Fold and unfold the wings several times and hold the hydraulic lever in the extended position for 30 seconds each time to purge air from the system.



Figure 3.14 Transporting II

3. Be sure the wings are resting securely on the wing supports (A).



Figure 3.15 Transporting III

4. Raise the implement. Shut off the engine, apply the park brake and remove the key from the tractor. Install the cylinder locks (B) on both main frame wheel lift cylinders. Install the pins (C) in the cylinder locks (B).
5. Start the engine and lower the main frame onto the cylinder locks (B).



Figure 3.16 Transporting IV



Always bring the machine to a complete stop before folding/unfolding. Switching between transport and working positions while in motion may result in damage to the implement.

## Operation

### 3.5 Field Operation Preparation



Ensure all personnel are cleared from the area of implement operation.

1. Park the tractor on level ground.
2. Raise the main frame to maximum height. Shut off the engine and remove the key from the tractor. Remove the cylinder locks (A) from the main frame wheel lift cylinders.



Figure 3.17 Field Operation Preparation I

3. Install the cylinder locks (A) in the storage position.



Figure 3.18 Field Operation Preparation II

4. Start the tractor and unfold the wings.



Figure 3.19 Field Operation Preparation III



Always bring the machine to a complete stop before folding/unfolding. Switching between transport and working positions while in motion may result in damage to the implement.



When in working position, ensure wing fold cylinders are fully extended prior to field operation.

### 3.6 Field Operation Leveling Adjustments

The 483 Chisel Pro is leveled at delivery but leveling may be necessary due to soil conditions or extended use.

1. Raise and lower the lift wheels a number of times and hold the hydraulic lever in the raise position each time for 30 seconds to purge any air in the system.



Be sure the tractor and implement are parked on a level surface.

2. Lower the implement until the disks and chisels are about 1 inch (25 mm) above the ground. Take measurements from the top of the frame to the ground at the front (A) and rear (B) of each frame section. The measurements must be the same for the implement to operate level.



Figure 3.20 Field Operation Leveling Adjustments I

3. To change the height of the rear lift wheels, loosen the jam nuts (C) and lengthen the adjusting bolt (D) to lower the frame and shorten the adjusting bolt (D) to raise the frame. Tighten the jam nuts (C) against the frame bracket (E).

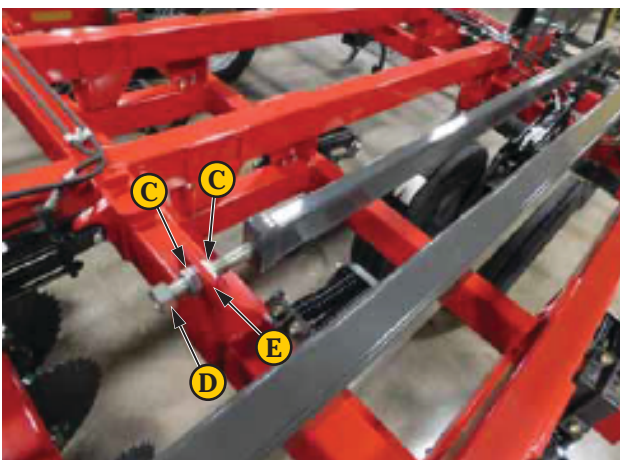

Figure 3.21 Field Operation Leveling Adjustments II

4. To change the height of the front lift wheels loosen the jam nut (F) and turn the adjusting nut (G) clockwise to raise the frame and counterclockwise to lower the frame.

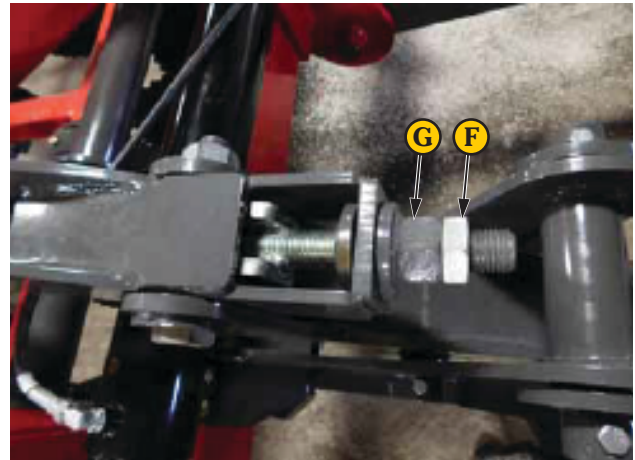

Figure 3.22 Field Operation Leveling Adjustments III

5. Repeat steps 3 and 4 until all frame sections are level front to rear and the wings are level with the main frame.



Figure 3.23 Field Operation Leveling Adjustments IV

## Operation

### 3.7 Field Operation Settings

#### Shank Depth Setting

1. In the field lower the implement to the ground and run a test strip. Use the lift wheels to change soil penetration depth until desired depth is achieved.



Figure 3.24 Shank Depth Setting I

2. Stop the tractor and check the soil penetration depth. Use the shank depth control adjuster (A) to fine tune the depth setting.

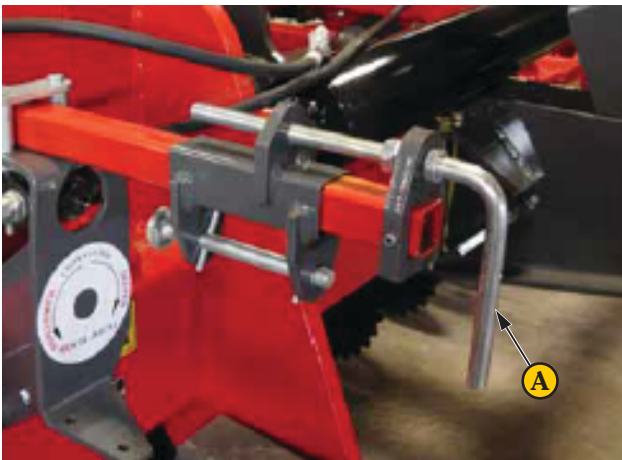

Figure 3.25 Shank Depth Setting II

3. Turn the shank depth control adjuster clockwise until the adjuster stop (B) contacts the lift wheel depth control valve (C). Turning the depth control adjuster clockwise will increase depth and counterclockwise will decrease the depth of the implement. The depth can be fine tuned 1/8 inch (3.2 mm) with one full turn of the adjuster handle.

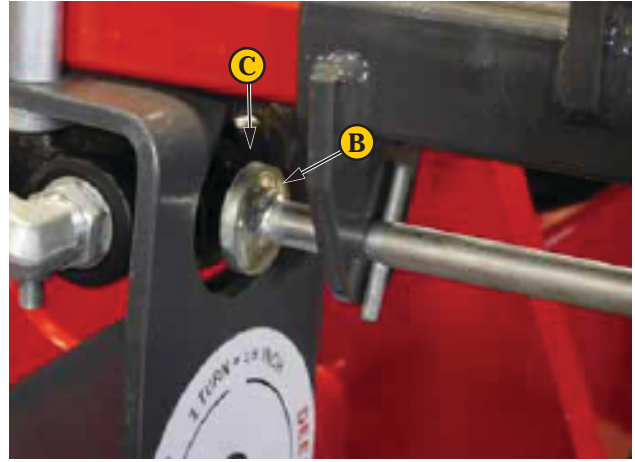

Figure 3.26 Shank Depth Setting III

4. Run a test strip and check the setting. Repeat this step until correct depth is achieved.



*Disk Depth Setting*

1. The disk depth can be set with the cylinder stops (A) located by the disk lift cylinders.

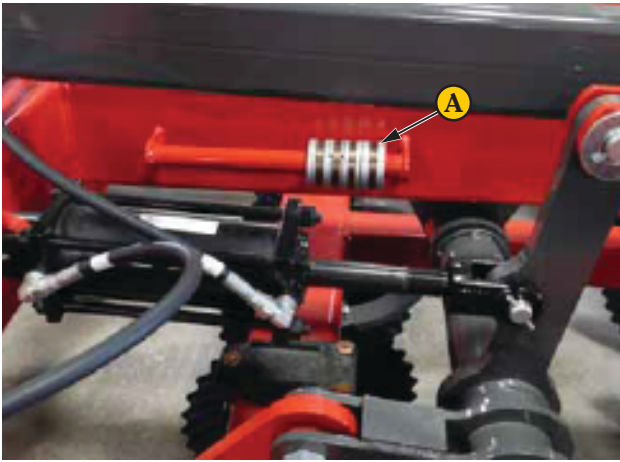

*Figure 3.27 Disk Depth Setting I*



The cylinder stops (A) must only be used on the main frame disk lift cylinders.

2. Install one to four cylinder stops (A) on the main frame disk lift cylinders. Each stop will restrict the depth of penetration of the disks.



*Figure 3.28 Disk Depth Setting II*

## Operation

### Flat Bar Rolling Basket Setting

1. Lower the rolling baskets (A) to the ground.



Figure 3.29 Flat Bar Rolling Basket Setting I

2. Hold the hydraulic lever in the down position and read the rolling basket system pressure gauge (B).



Figure 3.30 Flat Bar Rolling Basket Setting II



The down pressure is factory set at 1000 psi (6894.76 kPa).

3. To change the down pressure on the baskets, loosen the lock disk (C) and turn the control knob (D) clockwise to increase and counterclockwise to decrease the down pressure.

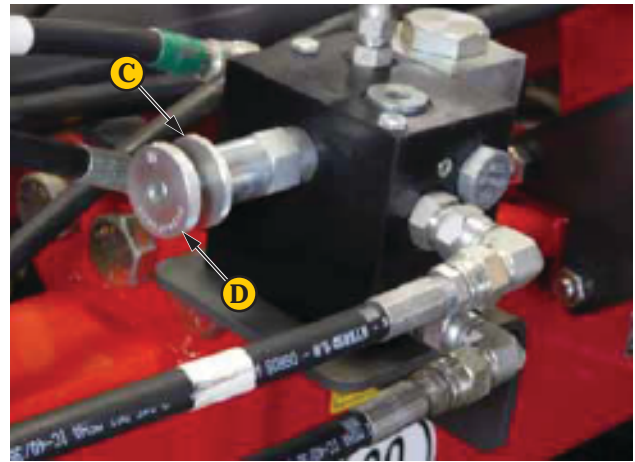

Figure 3.31 Flat Bar Rolling Basket Setting III

4. To put the baskets in FLOAT mode move the control valve lever (E) from the horizontal position shown to the vertical (F) position. In FLOAT mode the only down pressure is the weight of the basket assemblies.

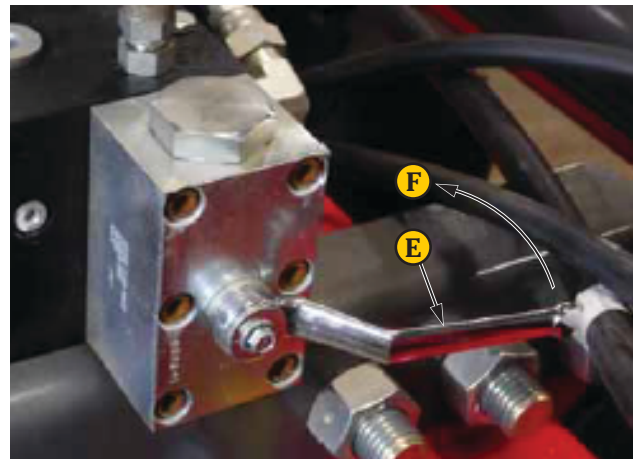

Figure 3.32 Flat Bar Rolling Basket Setting IV

*Hydraulic Basket Operation*

- With the hydraulic rolling basket, there are several adjustments to achieve the best residue management. Depending on field conditions, adjustments can be made to create an even, level surface finish.
- **Dry Field Conditions**
  - During dry field conditions, the active down pressure can be used. The factory setting is at 1000 psi. If more basket crumbling action and residue pinning is required, increase the down pressure applied to the baskets (raise gauge pressure). Be careful not to set the pressure too high, or the basket will lift the coil tines harrows and rear chisels out of the ground.
- **Normal Field Conditions**
  - During normal field conditions the active down pressure can be used. The factory setting (1000 psi) is a good place to start. Depending on residue and soil surface finish, pressure can either be lowered or raised to achieve optimal soil finish. If less soil crumbling and residue pinning is desired the psi can be reduced.
- **Wet Field Conditions**
  - During wet field conditions the float condition may be used. This operation may be useful when the basket begins to acquire soil. Float will allow basket to lightly float over the soil while still pinning residue and breaking up soil clumps without acquiring soil on the baskets. If the baskets begin to acquire too much soil, they can be raised to just allow the coil tine harrow to level the soil and residue.

*Coil Tine Harrow Settings*



The harrows are set at factory but due to soil conditions or wear of the coil tines they may need to be adjusted for the desired effect.

1. To increase or decrease the down pressure on the tines loosen the jam nuts (A). Turn both nuts (A) clockwise to increase down pressure or counterclockwise to decrease down pressure. Tighten the two jam nuts (A) on the bracket (B).

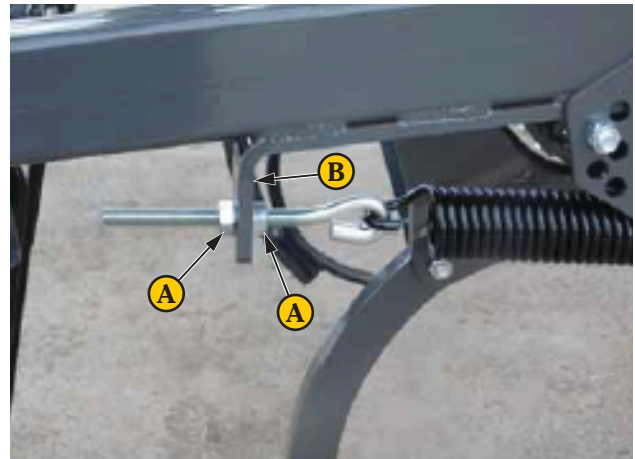

*Figure 3.33 Coil Tine Harrow Settings I*

2. The maximum depth of the harrow assembly is controlled by the position of the stop bolt (C) in the harrow arm bracket. The lower the position (D) of the bolt (C) the deeper the harrow penetration.

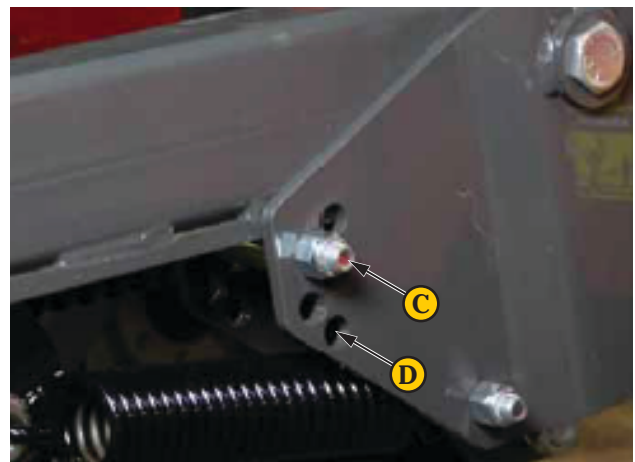

*Figure 3.34 Coil Tine Harrow Settings II*

## Operation

3. To change the pitch of the harrow tines remove the retaining pin (E).

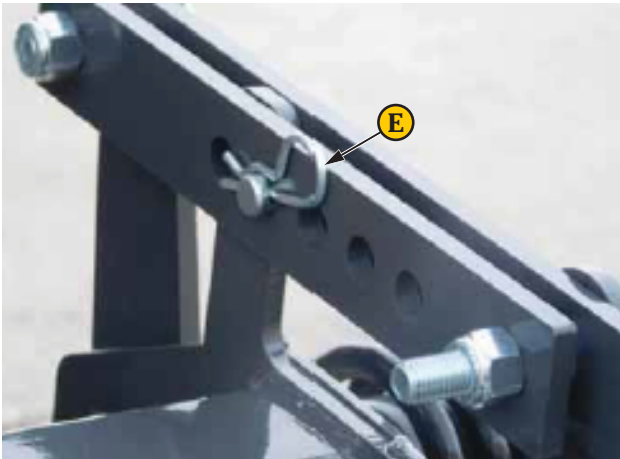

Figure 3.35 Coil Tine Harrow Settings III

4. Remove the pin. Move the pin forward (F) to decrease the pitch and back (G) to increase. Install the retaining pin from Step 3.



The more vertical the pitch of the tines is the more aggressively the harrow will penetrate the soil. The increased pitch will allow more debris to pass through the harrow.



Figure 3.36 Coil Tine Harrow Settings IV

5. The front (H) to back (I) leveling of the harrow assembly can be changed to keep the harrow level when the depth of the disks and shanks are changed or to change the penetration from the front to the rear tines.



Figure 3.37 Coil Tine Harrow Settings V

6. Remove the bolts (J), lock nuts and washers. Position the harrow assembly arm forward (K) for shallow disk / shank settings and rearward (L) for deeper settings. Install the bolt, washer and lock nut (J) when set.



The same setting must be used on all harrow sections.

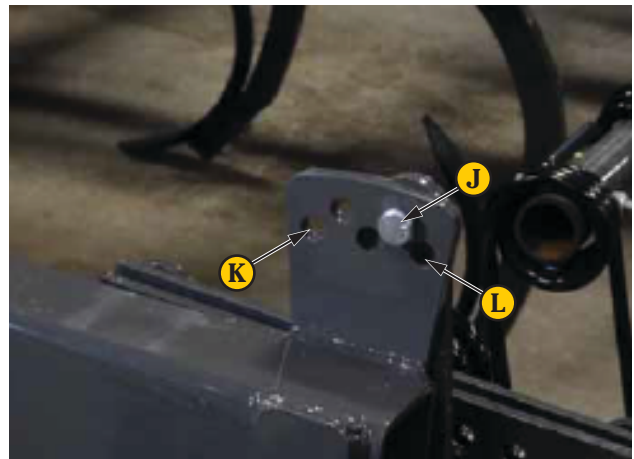

Figure 3.38 Coil Tine Harrow Settings VI



# 4 Troubleshooting

## 4.1 Troubleshooting the Chisel Pro

Table 4.1 Troubleshooting the Chisel Pro

Possible Cause	Solution
<b>Lift cylinders are not in place</b>	
There is air in the system.	Bleed the system by extending the cylinders and hold the hydraulic lever for 1 to 5 minutes.
<b>Wings are lowering with hydraulic lever in neutral</b>	
Hydraulic fluid is flowing past the cylinder pistons.	Install new seals in the cylinder or replace the cylinder.
<b>Wheel lift cylinders are allowing the implement to lower</b>	
Hydraulic fluid is flowing past the lift cylinder pistons.	Install new seals in the cylinders or replace the cylinders.
<b>The implement is not pulling evenly</b>	
Depth is not even.	Level the wings and center frame.
Shanks or disks are worn or broken.	Replace worn or damaged shanks or disks.
<b>The depth is not even</b>	
The implement is not level when under power.	Level the implement front to rear and the wings with the center frame.
<b>Wings are bouncing</b>	
The implement is operating too fast.	Reduce speed.
The outside edge of the wings is too deep.	Level the wings with the center frame.



## 5 Maintenance

### 5.1 Maintenance Schedules

#### 5.1.1 Daily

1. Inspect all bolts and fasteners for tightness and damage.
2. Replace any damaged fasteners immediately.



Loose bolts or fasteners can result in damage to the implement.

3. Check hydraulic hoses and fittings for leaks or damage. Tighten or replace immediately.



Figure 5.1 Hydraulic Maintenance

4. Check the wing hinges for excessive wear, damaged or bent parts or links.



Figure 5.2 Wing Hinges

5. Check the shanks (A) for excessive wear, damage or broken parts on shovels (B).



A bent or worn shank can effect the efficiency of the Chisel Pro.

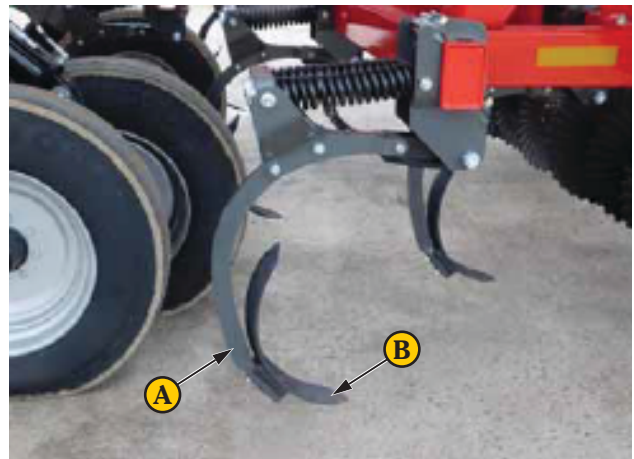

Figure 5.3 Shanks / Shovels

6. Check the rolling basket (C) for excessive wear or damage.



Figure 5.4 Rolling Basket

7. Lubricate the pivots (D) on the front gauge wheels.



Figure 5.5 Front Gauge Wheel Pivots



### 5.1.2 Every 50 Hours

1. After the initial pre-operation lubrication, the rear rolling baskets (A) must be lubricated with clean multipurpose heavy duty lithium grease every 50 hours of operation.

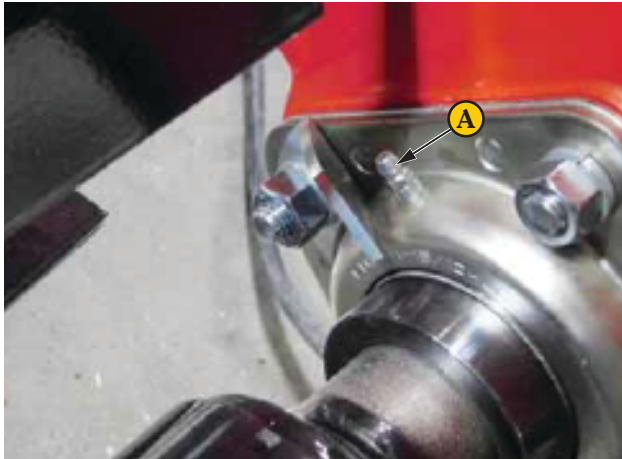

Figure 5.6 Rear Rolling Basket Lubrication

2. Lubricate the wheel hubs (B). Check the wheel lug bolts (C) for correct torque. Tighten lug bolts (C) to 90 ft-lbs (122 N.m)

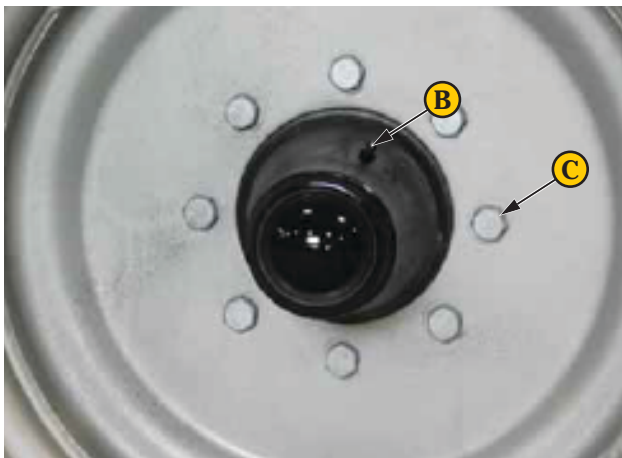

Figure 5.7 Wheel Hubs

3. Check the air pressure in all tires. The front gauge wheels must be at 55 psi (3.7 bar). The rear main frame lift wheels must be at 70 psi (4.8 bar).



Figure 5.8 Tire Pressure

4. Clean dirt, debris or grease from all moving parts.

### 5.1.3 1000 Hours / Yearly

1. Remove all dirt and debris from the implement that could hold moisture and cause rusting.
2. Repaint any chipped areas or clean and paint rusted areas.
3. Inspect the machine for any worn or damaged parts and replace immediately.
4. Grease the rolling basket bearings as in the 50 hours maintenance schedule.

### 5.2 Storage

#### 5.2.1 Preparing the Machine for Storage

Prepare the machine for storage at the end of each season. When possible, store the machine in a covered location with the wings lowered. Preventing rust will lengthen the life and assist in performance.

##### *Procedure*

1. Park the implement on a solid, level surface, away from other machines.
2. Use the tractor hydraulics to lower the wings of the implement.
3. Clean the implement of any dirt, grease or other materials.
4. Put a protective layer of heavy oil or grease on all earth engaging parts to prevent rust.
5. Paint any damaged surfaces, surfaces with paint removed, or surfaces with rust.
6. Inspect the implement for any loose parts or hardware.
  - Replace any worn parts.
  - Tighten any loose hardware.

7. Lubricate all components of the implement.
8. Raise the implement and transport to the area where it is to be kept. The area must be level.
9. Stop the engine, apply the park brake, and take the key with you.
10. Place boards under the disks and shanks.



If boards cannot be placed under the disks and shanks, place the cylinder stops on the main frame lift cylinders. Lower the implement onto the cylinder stops. This will prevent the disks and shanks from penetrating the ground.

---

11. Start the engine and lower the implement on the boards under the shanks.
12. Completely retract the wheel lift cylinders.
13. Use the front hitch jack to support the front hitch of the implement.
14. Remove the tractor from the implement.
15. Apply grease to the surfaces of the cylinder rods that are still showing.



## 6 Specifications

### 6.1 Implement Specifications

Table 6.1 2025 483 Chisel Pro

Models	483-16	483-19	483-24	483-29	483-34
<b>Dimensions</b>					
Working Width, ft (m)	16.25 (5)	18.75 (5,7)	25 (7.6)	28.75 (8.8)	33.75 (10.3)
Shank Spacing, in (cm)	15 (38)	15 (38)	15 (38)	15 (38)	15 (38)
Transport Width, ft (m)	17.5 (2.3)	20 (6)	20 (6)	20 (6)	20 (6)
Transport Height, ft (m)	6 (1.8)	6 (1.8)	12 (3.7)	13 (4)	15 (4.6)
Transport Length, ft (m)	35.3 (10.8)	35.3 (10.8)	35.3 (10.8)	35.3 (10.8)	35.3 (10.8)
Weight, lbs (kg)	15,469 (7,017)	16,981 (7,702)	27,157 (12,318)	29,879 (13,553)	33,103 (15,015)
<b>Specifications</b>					
Number of Shanks	13	15	19	23	27
Number of Blades	24	32	40	48	56
Horsepower Requirement	240 — 360	300 — 450	380 — 570	460 — 620+	540 — 620+

#### 6.1.1 Wheels

Table 6.2 Tire Pressure

Unit	Front Gauge Wheels	Rear Lift Wheels
All Models	55 psi (3.7 bar)	70 psi (4.8 bar)

Table 6.3 Lug Nut Torques

Unit	Front Gauge Wheels	Rear Lift Wheels
All Models	90 ft-lbs (122 N.m)	90 ft-lbs (122 N.m)

## 6.2 Standard Bolt Torques



Failure to follow these instructions may result in personal injury and/or equipment damage.

- Before and during operation be sure no one is on or around the implement.
- Before activating the hydraulic system, check hoses for proper connections.
- Before lowering the wings for the first time, make sure the entire system has been charged with oil.

- Tighten all loose nuts and bolts and replace any bent or broken parts.
- When tightening bolts, they must be torqued to the proper number of foot-pounds as indicated in the table unless specified. It is important that all bolts be kept tight.
- On new machines, all nuts and bolts must be rechecked after a few hours of operation.

- When replacing a bolt, use only a bolt of the same grade or higher. Except in shear bolt applications, where you must use the same grade bolt.

### SAE Bolt Grades

- **(A)** Bolts with no marking are grade 2.
- **(B)** Grade 5 bolts furnished with the machine are identified by three radial lines on the head.
  - All U-bolts are grade 5.
- **(C)** Grade 8 bolts furnished with the machine are identified by six radial lines on the head.

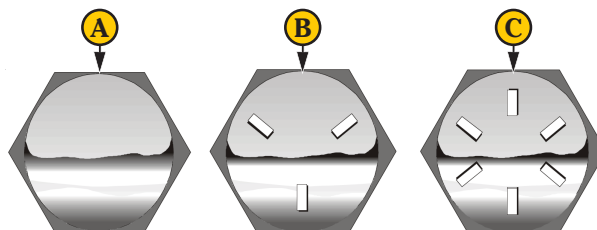

Figure 6.1 SAE Bolt Grades

Table 6.4 Standard Bolt Torques

Bolt Size	Wrench Size	Grade 5		Grade 8	
		lb-ft	N.m	lb-ft	N.m
1/4 in.	7/16 in. or 3/8 in.	7	9.5	12	17
5/16 in.	1/2 in.	15	20	25	34
3/8 in.	9/16 in.	30	41	45	61
7/16 in.	5/8 in. or 11/16 in.	45	61	70	95
1/2 in.	3/4 in.	70	95	105	142
9/16 in. (Wheel Bolts)	7/8 in.	170	231	-	-
5/8 in.	15/16 in.	170	231	210	285
5/8 in. (Wheel Nuts)	1-1/16 in.	240	325	-	-
3/4 in.	1-1/16 in.* or 1-1/8 in.*	250	339	375	509
7/8 in.	1-5/16 in.	350	475	600	814
1 in.	1-1/2 in.	450	610	880	1193
1-1/4 in.	1-7/8 in.	500	678	-	-
1-1/2 in.	2-3/4 in.	570	773	-	-
2 in.	3-1/8 in.	1200	1627	-	-

# Specifications

## 6.3 Hydraulic Connection Torques

### Hydraulic Connection Torques Legend

- **(1)** Straight Thread O-ring Boss (ORB)
  - Example: 12MB — 12MJ is —12 male ORB to —12 male JIC
- **(2)** SAE 37°C (JIC)
  - Example: 8FJ — 8FJ is —08 female JIC

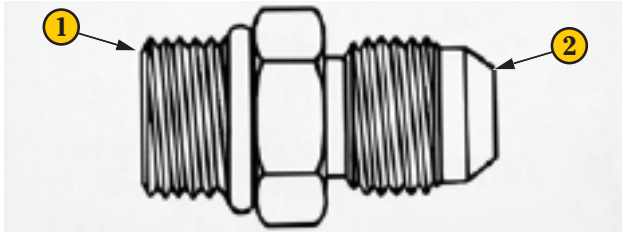

Figure 6.2 Hydraulic Connection Torques



SAE 37° fittings can be damaged if over torqued. Use caution when tightening these fittings.

Table 6.5 Straight Thread O-ring Boss (ORB)

Dash Size	Jam Nut or Straight Fitting Torque	
	ft/lbs	Newton Meters
-04	13 — 15	18 — 20
-05	14 — 15	19 — 21
-06	23 — 24	32 — 33
-08	40 — 43	55 — 57
-10	43 — 48	59 — 64
-12	68 — 75	93 — 101

Table 6.6 SAE 37°C (JIC)

Dash Size	Jam Nut or Straight Fitting Torque	
	ft/lbs	Newton Meters
-04	11 — 12	15 — 16
-05	15 — 16	20 — 22
-06	18 — 20	24 — 28
-08	38 — 42	52 — 58
-10	57 — 62	77 — 85
-12	79 — 87	108 — 119



## 7 Aftermarket

### 7.1 Warranty



Väderstad Inc. Limited Warranty Terms and Conditions — United States and Canada, Effective for Equipment Retailed and Delivered after May 21, 2021.

#### 7.1.1 What is Warranted

Väderstad Inc. warrants its new equipment to be free of defects in material and workmanship at time of delivery to the first retail purchaser, renter or lessee. These terms apply to all 10K, Amity, Concord, Wil-Rich and Wishek brands of new equipment originally marketed in the United States and Canada.

#### 7.1.2 Warranty Period

- 12 months from the date of delivery to the first retail purchaser, renter or lessee.
- **483 Disk Chisel, Field Cultivator and Disk Cultivators:** 3 years on main frames, wing frames and shank assemblies.

#### 7.1.3 Exceptions from this Warranty

- **Freight Charges:** This warranty does not cover freight charges.
- **Improvements, Changes, or Discontinuance:** Väderstad Inc. reserves the right to make changes and improvements in design or changes in specifications at any time to any product without incurring any obligations to owners of products previously sold.
- **Satellite Outages:** Interruptions in satellite interfaces and satellite communications are outside the control of this product and are not covered by this warranty. The company is not responsible for issues or degradation of system performance resulting from such interruptions in satellite interfaces and satellite communications where the issues are not related to defects in this product.
- **Repairs and Maintenance Not Covered Under Warranty:** This warranty does not cover conditions resulting from misuse, natural calamities, use of non-Väderstad Inc. parts, negligence, alteration, accident, use of unapproved attachments, usage which is contrary to the intended purposes, or conditions caused by failure to perform required maintenance. Replacement of wear or maintenance items (unless defective) such as but not limited to, filters, hoses, belts, lubricants, light bulbs, wheel alignment, tightening of nuts, belts, bolts and fittings, service tune-up, computer parameter adjustments and general adjustments which may from time to time be required are not covered.

- **Rubber Tire Warranty:** Rubber tires are warranted directly by the respective manufacturer only and not by Väderstad Inc.

#### 7.1.4 Owners Obligation

It is the responsibility of the owner to transport the equipment or parts to the service shop of an authorized Väderstad Inc. dealer or alternatively to reimburse the dealer for any travel or transportation expense involved in fulfilling this warranty. This warranty does NOT cover rental of replacement equipment during the repair period, damage to products which have been declared a total loss and subsequently salvaged, overtime labor charges, freight charges for replacement parts, or special handling requirements (such as, but not limited to, the use of cranes).

#### 7.1.5 Exclusive Effect of Warranty and Limitation of Liability



This warranty is in lieu of all warranties of merchantability, fitness for a purpose or other representations, warranties or conditions, expressed or implied.

The remedies of the owner set forth herein are exclusive. The company neither assumes nor authorizes any person to assume for it any other obligation or liability in connection with the sale of covered machines. Correction of defects, in the manner and for applicable period of time provided above, shall constitute fulfillment of all responsibilities of Väderstad Inc. to the owner, and Väderstad Inc. shall not be liable for negligence under contract or in any manner with respect to such machines.



In no event shall the owner be entitled to recover for incidental, special or consequential damages such as but not limited to, loss of crops, loss of profits or revenue, other commercial losses, inconvenience or cost of rental or replacement equipment.



Some states or provinces do not permit limitations or exclusions of implied warranties or incidental or consequential damages, so the limitations or exclusions in this warranty may not apply.



**Väderstad Inc. as referred to herein with respect to sales in:**

*United States & Canada:*

- Väderstad Inc.
- PO Box 1030
- Wahpeton, ND 58074

**7.1.6 Additional Warranty Information**

**New Equipment Warranty**

Equipment is eligible for warranty service only if it qualifies under the provisions of the new equipment warranty. The selling dealer will deliver this warranty to the original retail purchaser at the time of sale, and the dealer will register the sale and warranty with Väderstad Inc.

**Subsequent Owners**

This warranty covers the first retail purchaser and all subsequent owners of the equipment during the specified warranty period.

Should the Väderstad Inc. dealer sell this equipment to a subsequent owner, the dealer must deliver the warranty document to the subsequent owner so the subsequent owner can register ownership with Väderstad Inc. and obtain the remaining warranty benefits, if available, with no intermission in the warranty period. Subsequent owner procedure will apply. It is the responsibility of the subsequent owner to transport the equipment to the service shop of an authorized Väderstad Inc. dealer or alternatively to reimburse the dealer for any travel or transportation expense involved in fulfilling this warranty. This warranty does NOT cover charges for rental or replacement equipment during the repair period, products which have been declared a total loss and subsequently salvaged, overtime labor charges, freight charges for replacement parts, or units sold at auction.

**Warranty Service**

To be covered by warranty, service must be performed by an authorized Väderstad Inc. It is recommended that you obtain warranty service from the dealer who sold you the equipment because of that dealer's continued interest in you as a valued customer. In the event this is not possible, warranty service may be performed by any other authorized Väderstad Inc. dealers in the United States or Canada. It is the responsibility of the owner to transport the equipment to the service shop of an authorized Väderstad Inc. dealer or alternatively to reimburse the dealer for any travel or transportation expense involved in fulfilling this warranty.

**Maintenance Service**

The owner's manual furnished to you with the equipment at the time of delivery contains important maintenance and service information. You must read the manual carefully and follow all the maintenance and service recommendations. Doing so will result in greater satisfaction with your equipment and help avoid service and warranty problems. Please remember that failures due to improper maintenance of your equipment are not covered by warranty.

**Maintenance Inspections**

To insure the continued best performance from your agricultural equipment, we recommend that you arrange to make your equipment available to your selling dealer for a maintenance inspection 30 days prior to warranty expiration.

**7.2 Optional Attachments**

**7.2.1 Leveling Attachments**

Optional leveling attachments of a three-bar harrow, four-bar harrow, or three-bar harrow with hydraulic rolling basket with adjustable down pressure leave a smooth field finish for spring seedbed preparation. Contact your local Väderstad Inc. dealer for more information.

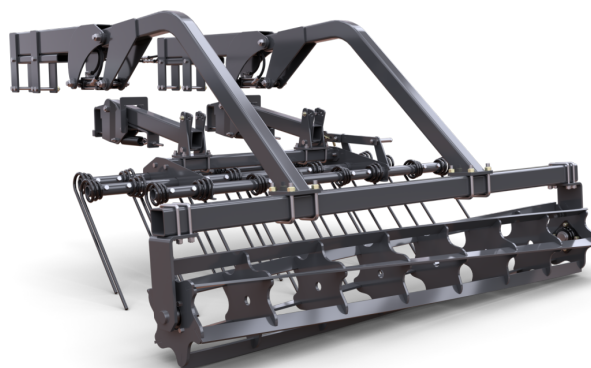

*Figure 7.1 Leveling Attachments*



---

**TABLES**

---

Table 1.1 Technical Data Sheet: 2025 483 Chisel Pro.....	5	Table 6.2 Tire Pressure .....	40
Table 2.1 Hand Signals .....	8	Table 6.3 Lug Nut Torques .....	40
Table 4.1 Troubleshooting the Chisel Pro .....	34	Table 6.4 Standard Bolt Torques .....	41
Table 6.1 2025 483 Chisel Pro.....	40	Table 6.5 Straight Thread O-ring Boss (ORB) .....	42
		Table 6.6 SAE 37°C (JIC) .....	42

## FIGURE

Figure 1.1 483–34F Chisel Pro (Top).....	2	Figure 3.7 Lubrication IV.....	23
Figure 1.2 483–34F Chisel Pro (Folded).....	3	Figure 3.8 Connecting the Implement I.....	24
Figure 1.3 483–34F Chisel Pro (Side).....	3	Figure 3.9 Connecting the Implement II.....	24
Figure 1.4 Serial No. Decal.....	4	Figure 3.10 Connecting the Implement III.....	24
Figure 2.1 (1) Crushing Hazard.....	13	Figure 3.11 Connecting the Implement IV.....	24
Figure 2.2 (1) Location I.....	13	Figure 3.12 Connecting the Implement V.....	24
Figure 2.3 (1) Location II.....	13	Figure 3.13 Transporting I.....	25
Figure 2.4 (2) Stand Clear.....	14	Figure 3.14 Transporting II.....	25
Figure 2.5 (2) Location.....	14	Figure 3.15 Transporting III.....	25
Figure 2.6 (3) Prevent Serious Injury from Moving Parts.....	14	Figure 3.16 Transporting IV.....	25
Figure 2.7 (4) Bleed Air From All Series Cylinders.....	14	Figure 3.17 Field Operation Preparation I.....	26
Figure 2.8 (3) Location I.....	14	Figure 3.18 Field Operation Preparation II.....	26
Figure 2.9 (3) Location II / (4) Location.....	14	Figure 3.19 Field Operation Preparation III.....	26
Figure 2.10 (5) Read Manual Before Connecting.....	15	Figure 3.20 Field Operation Leveling Adjustments I.....	27
Figure 2.11 (6) Read Manual Before Disconnecting.....	15	Figure 3.21 Field Operation Leveling Adjustments II.....	27
Figure 2.12 (5) Location / (6) Location.....	15	Figure 3.22 Field Operation Leveling Adjustments III.....	27
Figure 2.13 (7) Shut Engine Off.....	16	Figure 3.23 Field Operation Leveling Adjustments IV.....	27
Figure 2.14 (8) Read Manual.....	16	Figure 3.24 Shank Depth Setting I.....	28
Figure 2.15 (7) Location / (8) Location I.....	16	Figure 3.25 Shank Depth Setting II.....	28
Figure 2.16 (8) Location II.....	16	Figure 3.26 Shank Depth Setting III.....	28
Figure 2.17 (9) Electrocutation Hazard.....	17	Figure 3.27 Disk Depth Setting I.....	29
Figure 2.18 (10) Hydraulic Hazard.....	17	Figure 3.28 Disk Depth Setting II.....	29
Figure 2.19 (9) Location I.....	17	Figure 3.29 Flat Bar Rolling Basket Setting I.....	30
Figure 2.20 (9) Location II / (10) Location.....	17	Figure 3.30 Flat Bar Rolling Basket Setting II.....	30
Figure 2.21 (11) Maximum Safe Travel Speed.....	18	Figure 3.31 Flat Bar Rolling Basket Setting III.....	30
Figure 2.22 (11) Location.....	18	Figure 3.32 Flat Bar Rolling Basket Setting IV.....	30
Figure 2.23 (12) Amber Reflector.....	18	Figure 3.33 Coil Tine Harrow Settings I.....	31
Figure 2.24 (12) Location I.....	18	Figure 3.34 Coil Tine Harrow Settings II.....	31
Figure 2.25 (12) Location II.....	18	Figure 3.35 Coil Tine Harrow Settings III.....	32
Figure 2.26 (13) Red-Orange Reflector.....	19	Figure 3.36 Coil Tine Harrow Settings IV.....	32
Figure 2.27 (13) Location.....	19	Figure 3.37 Coil Tine Harrow Settings V.....	32
Figure 2.28 (14) Red Reflector.....	19	Figure 3.38 Coil Tine Harrow Settings VI.....	32
Figure 2.29 (14) Location.....	19	Figure 5.1 Hydraulic Maintenance.....	36
Figure 2.30 (15) Slow Moving Vehicle.....	20	Figure 5.2 Wing Hinges.....	36
Figure 2.31 (15) Location.....	20	Figure 5.3 Shanks / Shovels.....	36
Figure 2.32 (16) Serial Number Plate.....	20	Figure 5.4 Rolling Basket.....	36
Figure 2.33 (16) Location.....	20	Figure 5.5 Front Gauge Wheel Pivots.....	36
Figure 2.34 Safety Lighting.....	20	Figure 5.6 Rear Rolling Basket Lubrication.....	37
Figure 3.1 Hydraulic Connection Decal.....	22	Figure 5.7 Wheel Hubs.....	37
Figure 3.2 Hydraulic Preparation.....	22	Figure 5.8 Tire Pressure.....	37
Figure 3.3 Wheel Preparation.....	22	Figure 6.1 SAE Bolt Grades.....	41
Figure 3.4 Lubrication I.....	23	Figure 6.2 Hydraulic Connection Torques.....	42
Figure 3.5 Lubrication II.....	23	Figure 7.1 Leveling Attachments.....	45
Figure 3.6 Lubrication III.....	23		

**Index**

Connecting the Implement.....	24	Maintenance Safety.....	10
Electrical Safety .....	11	Preparation.....	22
Field Operation Leveling Adjustments.....	27	Safety Sign Information .....	7
Field Operation Preparation .....	26	Safety Signs.....	13
Field Operation Settings.....	28	Storage Safety.....	11
Hand Signals .....	8	Technical Data Sheet.....	5
Hazards .....	12	Tire Safety .....	11
Hydraulic Safety.....	10	Transport & Towing Safety.....	11
Machine Serial Number .....	4	Transporting .....	25
		Warranty .....	44

PO Box 1030  
Wahpeton, ND  
58075, USA

**WIL-RICH<sup>®</sup>**



Where farming starts